

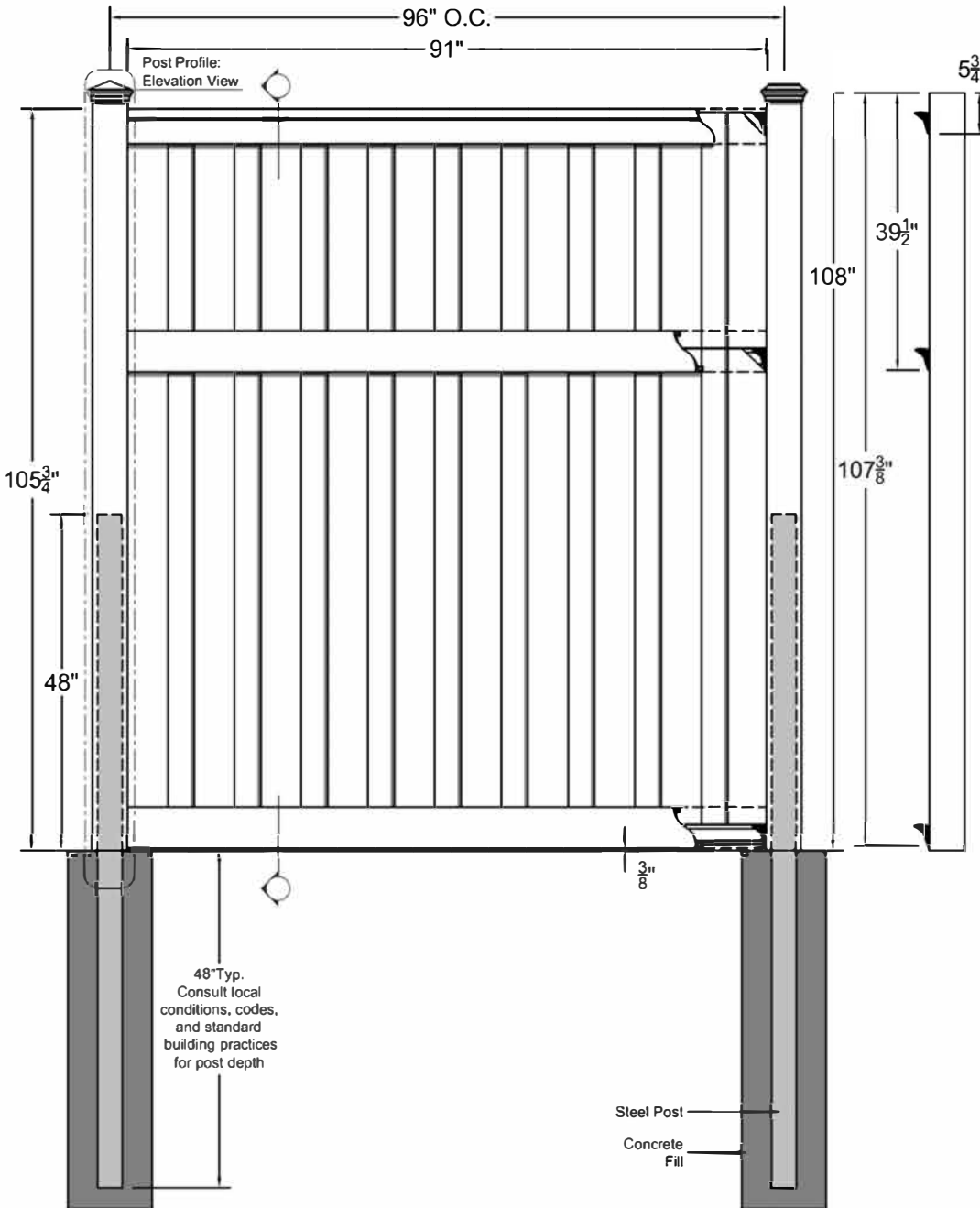









Composite Fencing

AVAILABLE FROM FDS DISTRIBUTORS, TREX COMPANY PRODUCT PARTNER



9' TREX SECLUSIONS		
MATERIAL NEEDED FOR 8' SECTION	QUANTITY	LENGTH
 Post Cap: Pyramid, Flat, or Crown	1	
 5" x 5" Post	1	144" *
 3.5"x3.5"x3/16 Galv. Steel Post	1	96"
 4" x 4.9" Top Rail	1	91" *
 1"x5.75" Interlocking Picket	19	67" *
 1"x5.75" Interlocking Picket (Cut to 33 3/8")	9.5	91" *
 1" x 5.75" Bottom Rail Cover	4	91" *
 Aluminum Bottom Rail	2	90 1/2"
 Fence Bracket	6	
1 5/8" Wood Screw	24	
3/4" x #8 Wood Screw	8	
1" Wood Screw	4	
1 1/2" x #14 Self-tapping Screw	2	

* Length may vary

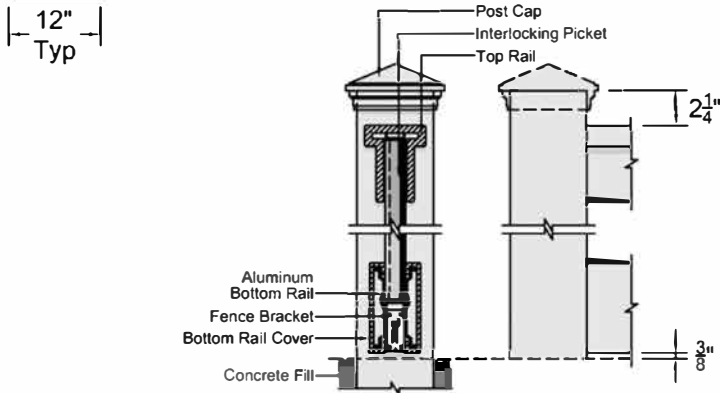

Post Profile: Cut View / Elevation View

NOTES:

1. INSTALLATION TO BE COMPLETED PER MANUFACTURER'S SPECIFICATION.
2. THIS DRAWING IS PROVIDED FOR PLANNING PURPOSES. REFER TO MANUFACTURER'S INSTALLATIONS FOR CONSTRUCTION DETAILS.
3. REFER TO MANUFACTURER'S WEBSITE FOR PRODUCT INFORMATION.
4. DRAWING NOT TO SCALE.

543 S 600E PROVO, UT 84606

1-877-700-8739 / WWW.YOURNEXTFENCE.COM

Copyright © 2018. FDS DISTRIBUTORS