

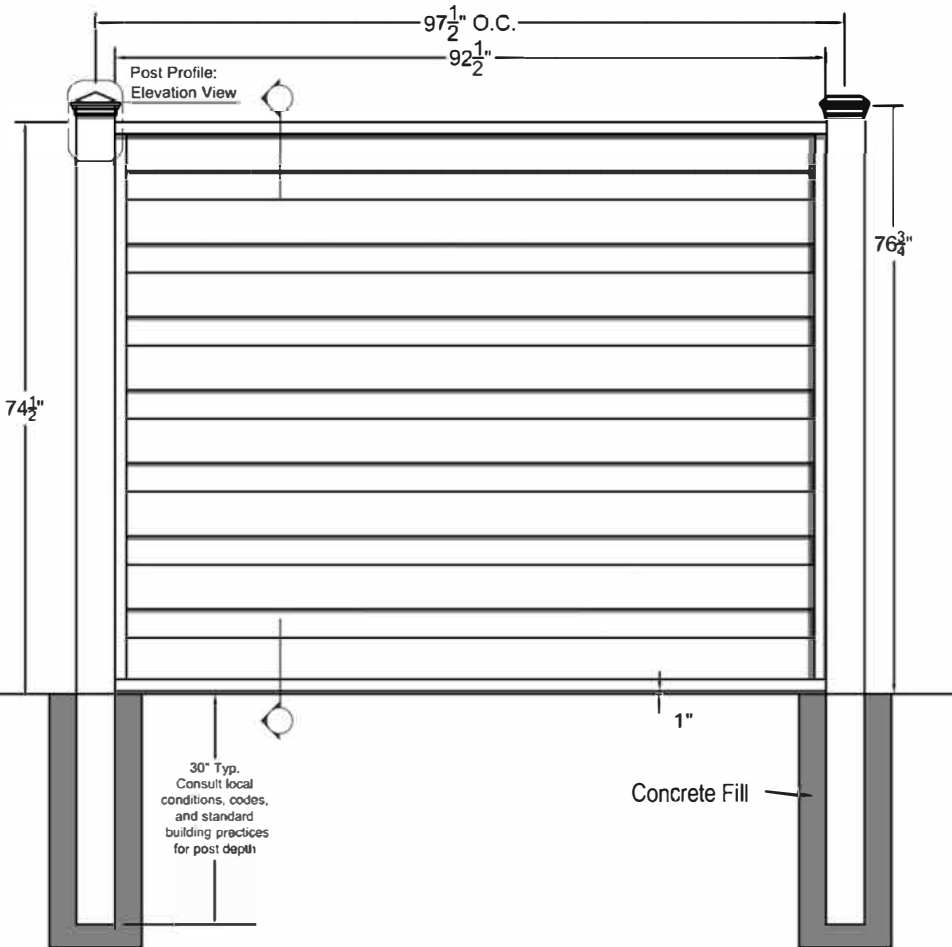





AVAILABLE FROM FDS DISTRIBUTORS, TREX COMPANY PRODUCT PARTNER

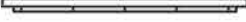

| 6' TREX HORIZONS | | |
|--|----------|---------|
| MATERIAL NEEDED FOR 8' SECTION | QUANTITY | LENGTH |
|  Post Cap: Pyramid, Flat, or Crown | 1 | |
|  5" x 5" Post | 1 | 108" * |
|  1.5" x 1.25" Horizontal Rail | 2 | 91" |
|  1"x5.75" Interlocking Picket | 15 | 91" * |
|  0.875" x 1.5" Vertical Back Rail | 2 | 73 1/2" |
|  0.5" x 1.5" Vertical Front Rail | 2 | 73 1/2" |
|  1.25" x 1.125" Rail Bracket | 2 | |

* Length may vary

| SCREWS | DIRECTIONS |
|--|---|
| #12-11 X 1" Large Black Hex Head Screw | Used for mounting brackets and vertical rails to post |
| #8-15 X 5/8" Small Black Hex Head Screw | Used for attaching horizontal and vertical front rails to pickets |
| #8-18 X 3/4" Self Tapping Black Hex Head Screw | Used for attaching vertical rails to horizontal rails in corners |

NOTES:

1. INSTALLATION TO BE COMPLETED PER MANUFACTURER'S SPECIFICATION.
2. THIS DRAWING IS PROVIDED FOR PLANNING PURPOSES. REFER TO MANUFACTURER'S INSTALLATIONS FOR CONSTRUCTION DETAILS.
3. REFER TO MANUFACTURER'S WEBSITE FOR PRODUCT INFORMATION.
4. DRAWING NOT TO SCALE.
5. CUTTING HORIZONS STEEL RAILS REQUIRES RECOATING WITH PAINT

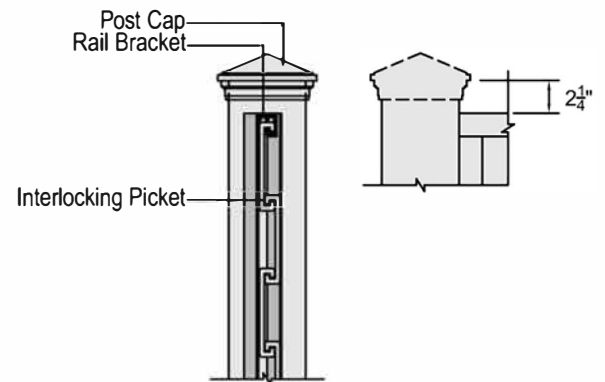

Post Profile: Cut View / Elevation View

TREX FENCE PROFILE: HORIZONS

534 E 600 S PROVO, UT 84606

1-877-700-8739 / WWW.YOURNEXTFENCE.COM

Copyright © 2018. FDS DISTRIBUTORS